



BLUM & WOLF

ACOUSTIC



**ACOUSTIC
pendant lamp
with sound absorbing
function**

Made of
high quality 100%
merino wool and
birch-plywood.
Textile cord,
ceramic ceiling-roses.

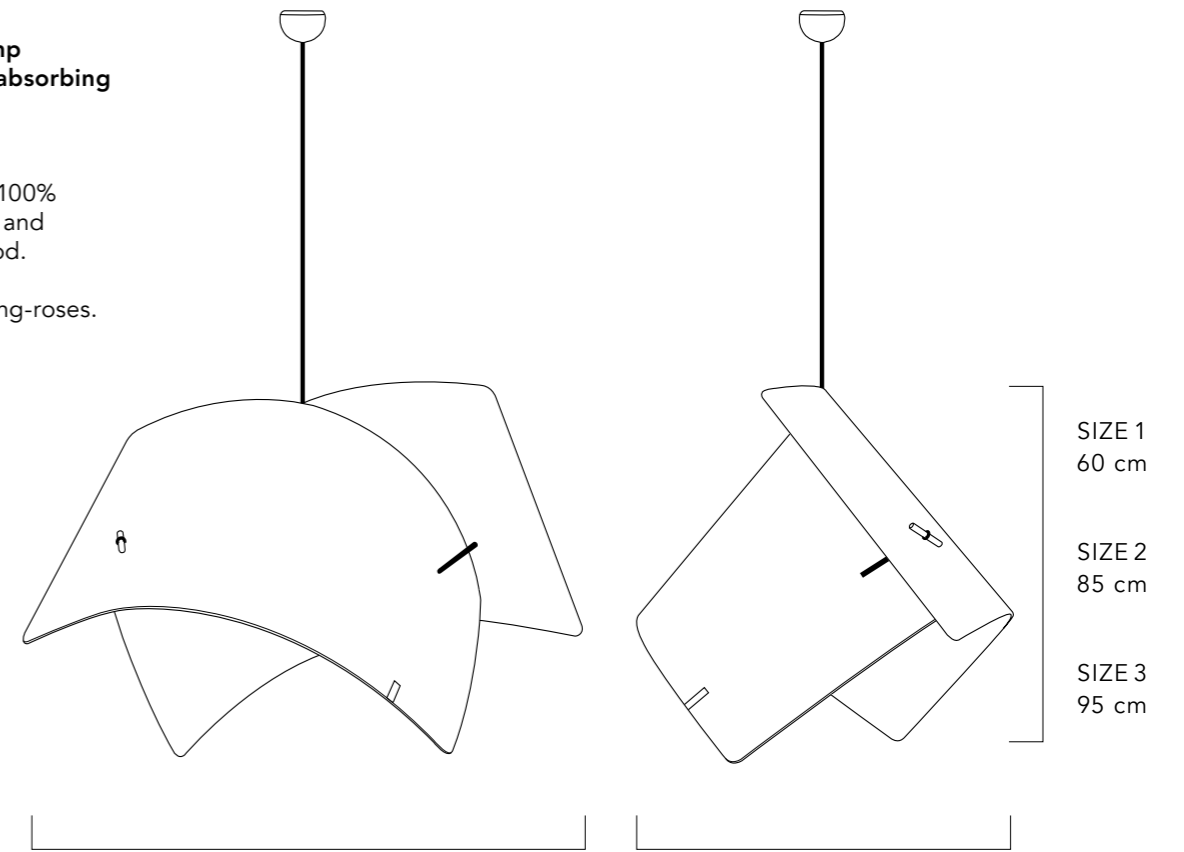

SIZE 1	85 cm	68 cm
SIZE 2	115 cm	98 cm
SIZE 3	138 cm	110 cm

SOCKET = E27, MAX. 20W LED • OPTIONAL – 2 × E27 with 2 × 20W capacity

FELT COLOUR OPTIONS

optional available almost every colour of the rainbow



304
Red



302
Yellow

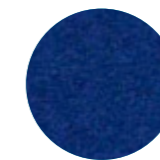

530
Dark blue



313
Violet

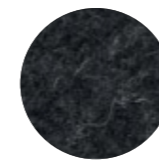

127
Anthracite

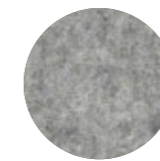

117
Grey melange

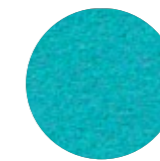

521
Turquoise

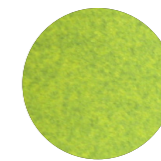

139
Field green



**BLUM & WOLF
ACOUSTIC PLY
PENDANT LAMP**



BLUM & WOLF
ACOUSTIC WALL PANEL

ACOUSTIC
sound absorbing
wall panel

Made of
high quality 100%
merino wool and
birch-plywood.

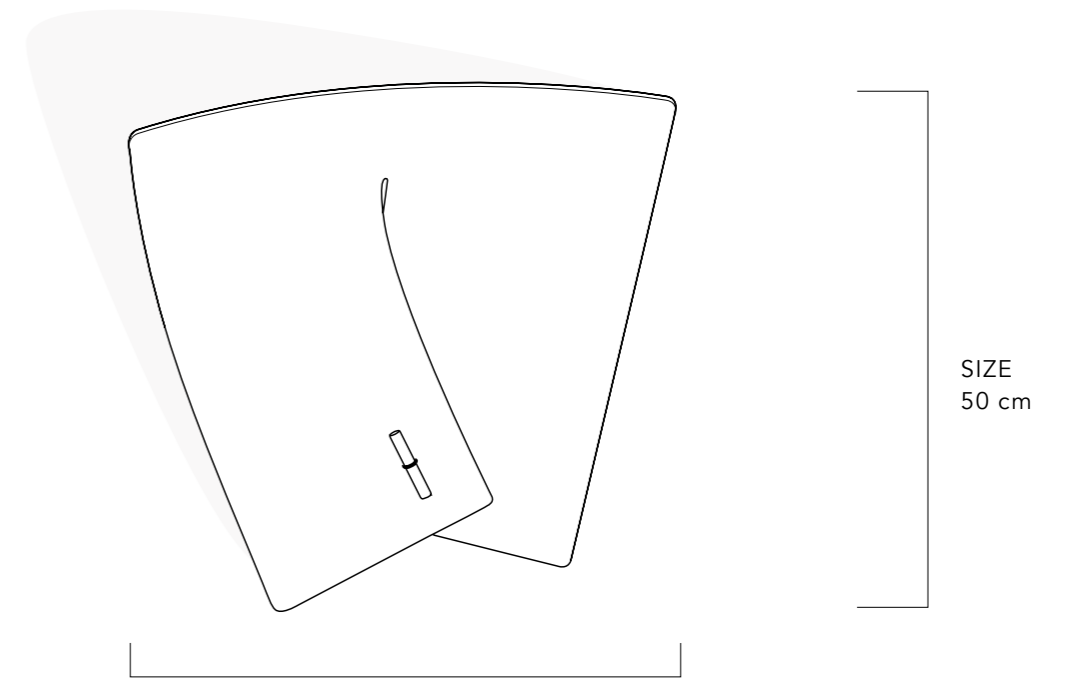

SIZE

48 cm

Optional available in different sizes.

FELT COLOUR OPTIONS

optional available almost every colour of the rainbow



304
Red



302
Yellow

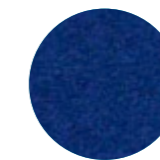

530
Dark blue



313
Violet



127
Antracite

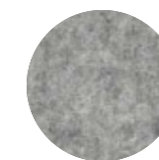

117
Grey melange



521
Turquoise

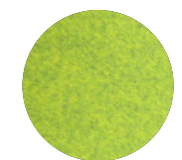

139
Field green



LUMINAIRE S

INSPIRATIONAL FINE LIGHTING

WWW.BLUMANDWOLF.COM

hello@blumandwolf.com • +36.20.4455.389